

Howe Performance

429 - 2.25 X 6 DOUBLE ENDED RAM FULL HYDRAULIC

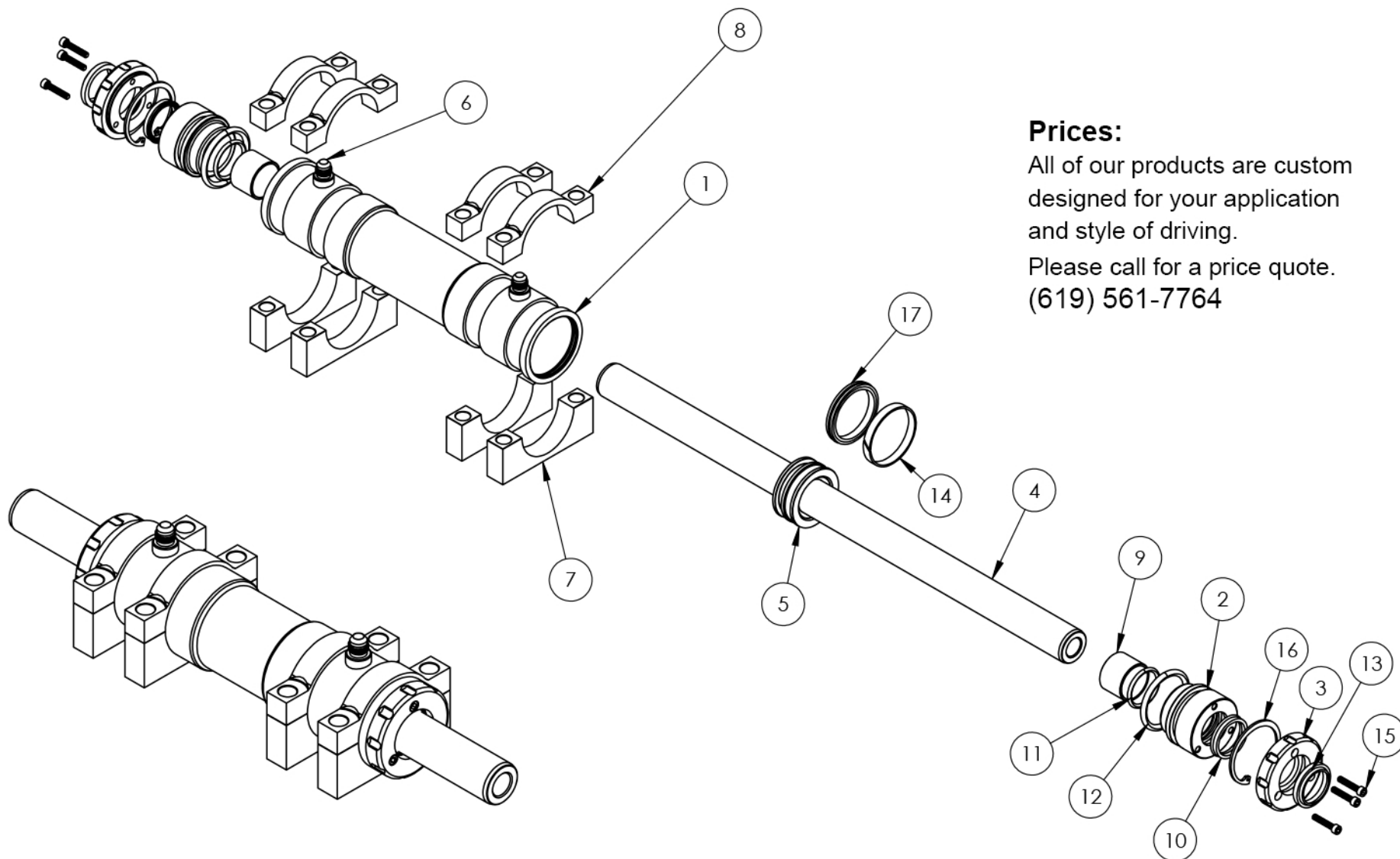

Prices:

All of our products are custom designed for your application and style of driving.

Please call for a price quote.
(619) 561-7764

For Off Hwy use only! All sales are final after 90 days. 15% Restock fee on all returns. No returns on custom parts. Copy of invoice must accompany all returned items. Not liable for installs or parts modifications. Seller will not be responsible for any labor time or charges incurred for any reason.

WARRANTY DISCLAIMER

Because of their intended usage, the manufacturer makes no warranties whatsoever, express or implied, oral or written to purchasers of their products regarding performance, safety, fit, merchantability, or length of service. Purchasers are responsible for selection of proper goods and must rely on their own skill or judgment that such goods are suitable for purchasers' application.

ITEM NO.	QTY.	DESCRIPTION
1	1	2-1/4 x 6 Double-Ended Ram Cylinder(Snap Ring Style)
2	2	2-1/4 Double-Ended Ram Seal Housing (1-1/4")
3	2	2-1/4 Double-Ended Ram Midcap (1-1/4")
4	1	2-1/4 x 6 Double-Ended Ram Shaft (1-1/4" Dia.)
5	1	2-1/4 Ram Piston Blank (1-1/4" Shaft)
6	2	Weld On -6 fitting JIC
7	4	2-1/4 Double-Ended Ram Clamp Bottom
8	4	2-1/4 Double-Ended Ram Clamp Top
9	2	20 TH 16 Shaft Bushing
10	2	Disogrin U-Cup Seal (DI001-093 D-Lock/ 1-1/4 x 1-1/2 x 1/4)
11	2	218 V75BR Viton O'Ring
12	2	328 B70 Buna O'Ring
13	2	D 1250 Slotted D Rod Wiper
14	1	2-1/4" Teflon Wearband
15	6	#10-32 x 1 Long SHCS
16	2	2-1/4 Internal Snap Ring
17	1	2-1/4 Beige Piston Seal (4300 PSP-328)